



*FEDERATION INTERNATIONALE
DE MOTOCYCLISME*

**FIM SOUND
REGULATIONS**

2025

FIM SOUND REGULATIONS

Règlement FIM pour le son

Modifications log		
Updated	Applicable as from	Modified articles
0	01.01.2025	D; E
1	09.01.2025	E
2	11.02.2025	E
3	17.03.2025	E
4	20.08.2025	E. 7.
5	30.09.2025	C; E.

Articles amended as from 01.01.2025 are in bold type
Articles amended during the 2025 season are in bold and **red type** or **strike**

Table of Contents

- A. INTRODUCTION..... 3
- B. PREPARATION OF THE SOUND METER..... 4
- C. SET UP OF THE MEASUREMENT 4
- D. TEST PROCEDURE 9
- E. SOUND LIMITS..... 14
- 1. TRIAL World Championships, Cups and Prizes 14
- 2. TRACK RACING World Championships, Cups and Prizes 14
- 3. FLAT TRACK World Championships, Cups and Prizes 14
- 4. ENDURO, SUPERENDURO, HARDENDURO World Championships, Cups and Prizes 14
- 5. SAND RACES World Championships, Cups and Prizes 15
- 6. CROSS-COUNTRY RALLIES & BAJAS World Championships and Cups 15
- 7. MOTOCROSS World Championships, Cups and Prizes 15

A. INTRODUCTION

In order to pursue the measures taken to reduce the sound level in favour of environment and in the framework of the 'RIDE QUIET' campaign, a new method for measuring the sound level called "2 metre max" is applied as from 2013 in all 'all-terrain' disciplines.

For the first World Championship event, all competitors' motorcycles will be checked for sound level. After the first event, the motorcycles of a 'wild card-' or 'one event' rider, will be checked for the sound level, as well as any other rider's motorcycle on a random basis.

Excessively loud motorcycles must always be checked, regardless of the participants' status.

The technical specifications and the resources to apply such a method, for the use of the technical stewards and officials, are outlined in the present article.

The "2 metre max" method shows a very good correlation between the sound power level (LWA) issued by motorcycles in full acceleration, and the maximum sound pressure levels measured at proximity of the same motorcycles, with engines at idle and quickly taken to their maximum rotational speeds.

The "2 metre max" method will consist in quantifying not only the sound level produced by the silencer of the exhaust, but the maximum global sound level achieved by the motorcycle when the engine rpm's are raised to the maximum engine speed, limited by a natural regulation (for 2 strokes) or rev limiters (for 4 strokes).

Only the sound levels measured with the "2 meter max" method will be considered by the technical stewards and by the Race Direction/Jury of the event to decide whether the motorcycle is in conformity with the maximum sound levels authorised.

For Motocross disciplines, Enduro/SuperEnduro/HardEnduro, Sand Races, Cross-Country Rallies and Bajas:

Before the opening of the season, the manufacturers must declare to the FIM International Technical Commission (CTI) at cti@fim.ch the maximum power rpm value of the engine of their motorcycles (in standard 'production' specification as sold on the market). The minimum threshold of rpm applied for each class for the sound control procedure will be defined and communicated by the FIM Technical Director.

No modification (in any possible way) of the original RPM channel is allowed. During the sound control, the engine must be able to reach its maximum admissible RPM level (meaning at least the minimum rpm set for each class by the FIM Technical Director according to the information provided by the manufacturers) in Neutral or In Gear position of the gearbox (at the discretion of the Sound Control Officer (SCO)).

The motorcycles fitted with ECU map select switches, all switch positions may be tested.

Furthermore, all systems of dB-Killers must be either the original part delivered by the exhaust manufacturer or made in a safe and professional (well-engineered) way. In case of dispute, the decision of the FIM Technical Director will be final.

B. PREPARATION OF THE SOUND METER

For all FIM championships and prizes, sound level meters must conform to the frequency response tolerance for Class 1 or Class 2 for nominal frequencies between 125Hz to 8000Hz, as stated by the IEC 61672-1:2013 subsection 5.5 standard.

All sound level meters must also conform to the tolerance for Class 1 or Class 2 for amplitude linearity, for its specified class, as stated by the IEC 61672-1:2013 subsection 5.6 standard. IEC 61672 is a regulatory document, which covers specifications and qualification requirements for class 1 and class 2 sound level meters.

Two sets of equipment must be available in case of failure of tachometer, sound level meter or calibrator during technical control.

Sound level measuring equipment must also include:

- a compatible calibrator, which must be used immediately before testing begins and always just prior to a re-test if a disciplinary sanction may be imposed;
- a tachometer.

The sound meter shall be prepared by applying the following procedure:

1. Activate the 'A' weighing
2. FAST time weighting must be activated
3. Select the highest range available (ex. 80~130 [dB])
4. Calibrate the sound meter according to the instructions, taking into account the incidence of the wind foam ball
5. Position the wind foam ball on the microphone
6. Activate the function MAX MIN – set on MAX

C. SET UP OF THE MEASUREMENT

The sound levels will be measured with the microphone fixed on a tripod at a height of 1.35 m above the ground, in horizontal (levelled) position. It is helpful to have the microphone equipped with an extension cable to the sound meter.

For the place and position of the motorcycle, ensure that there are no solid obstacles within 10 m around the microphone.

Depending on the vehicle, the sound meter will be positioned:

for Solo motorcycles: at an angle of 45° from the longitudinal axis of the vehicle, on the exhaust side, at a distance of 2 m behind the vehicle (measured from the point where the centre of rear tyre touches the ground).

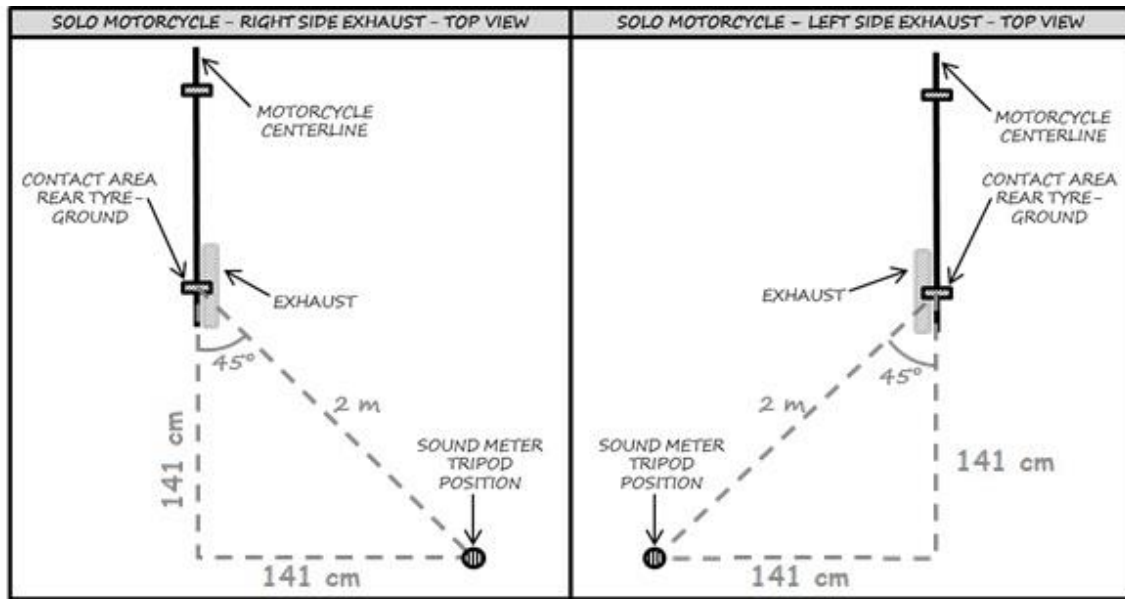

Figure 1 : Sound meter position for solo motorcycle

for Solo motorcycles with 2 exhaust outputs: at an angle of 45° from the longitudinal axis of the vehicle, on the side of the air intake, at a distance of 2 m behind the vehicle (measured from the point where the centre of rear tyre touches the ground). Note: if a central positioned air intake is used, both sides will be tested.

for Snowmobiles: at an angle of 90° from the longitudinal axis of the vehicle, on the side of the silencer, at a distance of 2 m next to the vehicle (measured from the silencer exit). For continuity of the measurement, use the handlebar as a reference to line up the motorcycle with the microphone - the exhaust pipe is usually located on the right hand side of the motorcycle and directly under the handlebar position. Note: the use of only one silencer is allowed for Snowmobiles.

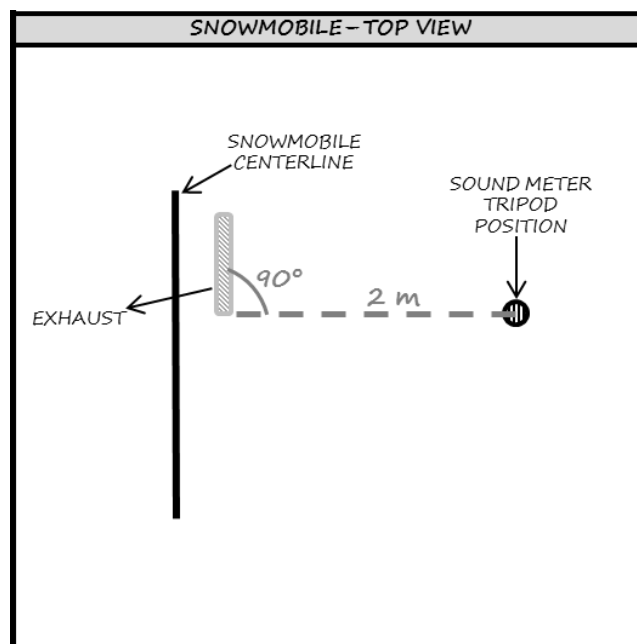

Figure 2: Sound meter position for solo snowmobile

for Sidecars: at an angle of 45° from the longitudinal axis of the vehicle, on the sidecar side, at a distance of 2 m behind the vehicle (measured from the point where the sidecar tyre touches the ground). If the exit of the silencer is closer to the motorcycle rear wheel, the reference point will be the contact point of the motorcycle rear wheel on the ground (as for Solo motorcycles).

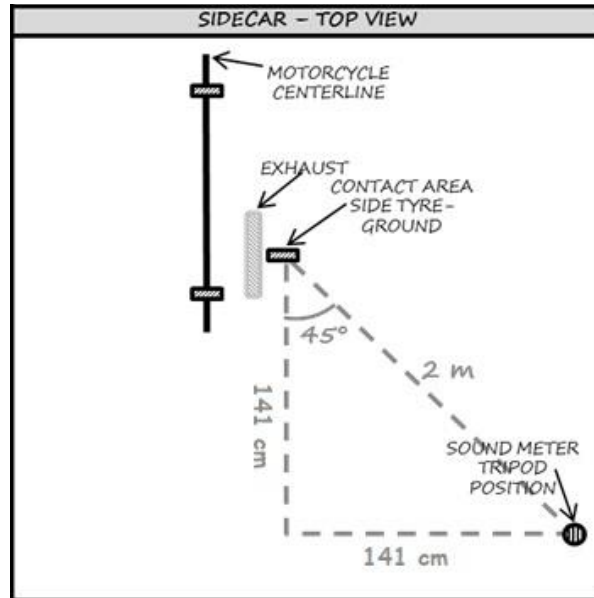

Figure 3: Sound meter position for sidecars

for Quads: at an angle of 45° from the median longitudinal axis of the vehicle, at a distance of 2 m behind the vehicle (measured from the point where the line drawn perpendicular to the rear axle touches the ground).

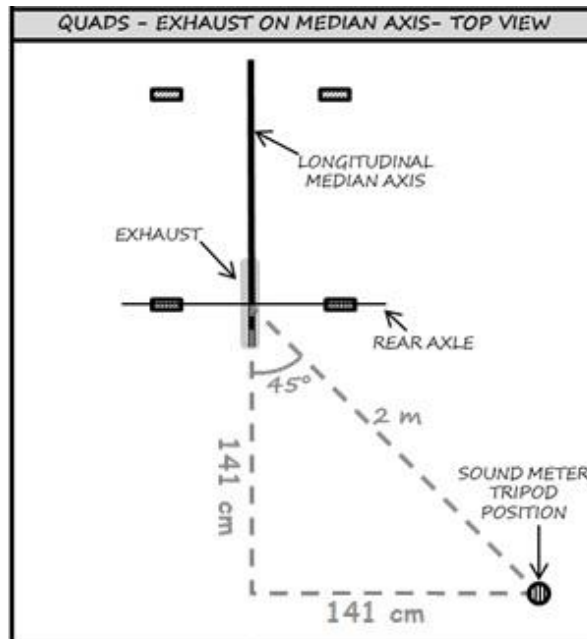

Figure 4: Sound meter position for quads

for Quads with the exhaust moved out of the median axis: at an angle of 45° from the rear axle, from where the rear axle and the exhaust meet, at a distance of 2 m behind the vehicle (measured from the point where the line drawn perpendicular to the rear axle touches the ground).

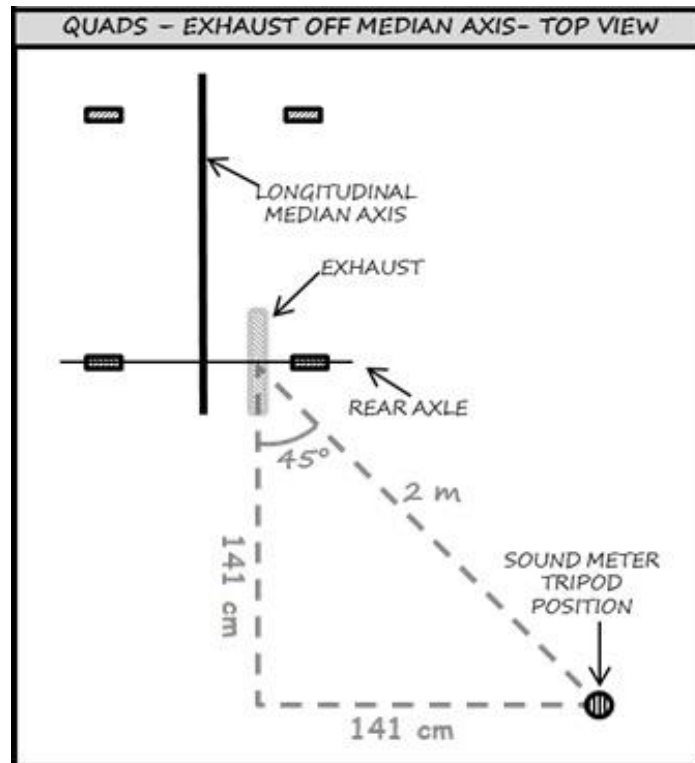

Figure 5: Sound meter position for solo motorcycle with exhaust moved out of the median axis

The sound level for engines with more than one silencer will be measured on each exhaust end.

Silencers fitted with adapters aiming to reduce the sound level shall be permanently fitted.

To make repetitive measurements, all motorcycles can be positioned into a small frame fixed on the ground, making sure to respect the 45° requirements. A squared frame helps the positioning of the motorcycle.

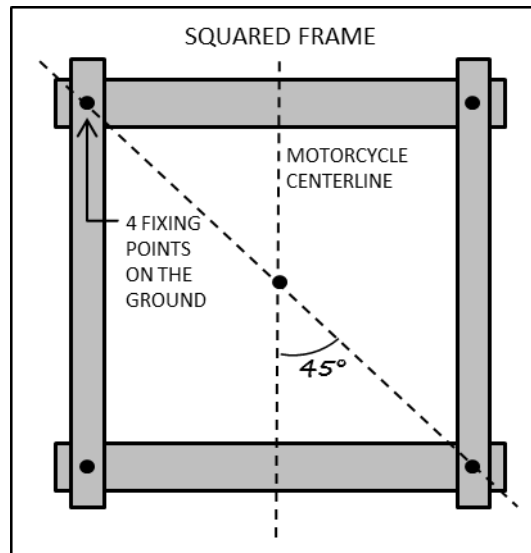

Figure 6 : Squared frame design

Vehicles which are not equipped with a gear box neutral must be placed on a stand.

It is preferred to make the tests on soft ground, not reverberating, i.e. grass or fine gravel.

~~In other than moderate wind, motorcycles should face forward against the wind direction.~~

We strongly recommend to the SCO, when practically possible, to always perform the sound measurements with the wind from backward to forward based on the motorcycle position (in favor of the rider). Please see hereunder:

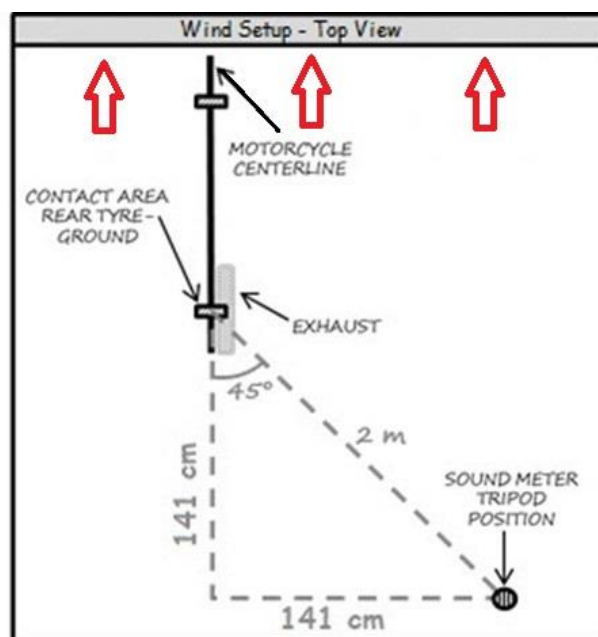

Figure 7 : Setup during windy conditions

The ambient sound at the point of measurement must be minimum 15 [dB/A] less than the lowest FIM sound limit applied in each discipline.

It is recommended to re-calibrate the sound meter before starting measurements and before putting the system away except when there has been any accident (physical impact to the equipment). In the event of an impact, the sound meter must be systematically re-calibrated before restarting any measurements.

D. TEST PROCEDURE

The Sound Control Officer (SCO) must be holder of a valid FIM Technical Stewards' license, come with good knowledge and experience of the sound control and application of the test method. The FMNR may propose the services from a special technician (acoustic engineer) if there is no FIM licenced Technical Steward available to act as SCO.

The SCO must have arrived in sufficient time for discussions with the Clerk of the Course/FIM Race Director and other Technical Officials in order that a suitable test site and testing procedure can be agreed.

The SCO (identified as "SCO" on the drawing here under) must be positioned on the right side of the vehicle, between the handlebar and the footrest, managing the throttle grip during the whole sound control procedure. During the sound control procedure, nobody can stand in the grey "prohibited" area between the muffler and the microphone area defined by the following drawing:

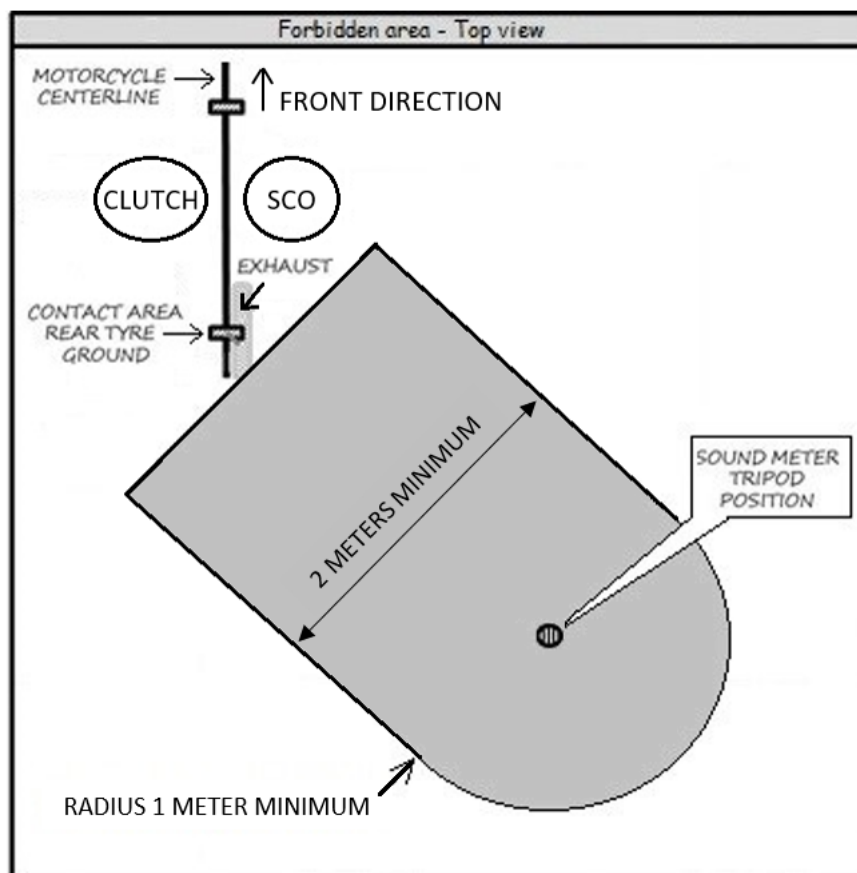

Figure 8 : Prohibited area during the Sound Control

A second technical steward can be present to help. The rider can also be present.

It is strongly advised that the technical steward(s) use earplugs, a headset or ear protectors.

The measurements are made with motorcycle on its wheels, with a hot engine, whatever in neutral gear position or in-gear position (at the discretion of the SCO). During the sound test, only the rider may sit on the vehicle in the normal riding position (at the discretion/decision of the SCO). For safety reasons, we recommend to the SCO to always keep the rear brake pedal under pressure during the sound control procedure.

The CLUTCH: a rider, a mechanic (or a second FIM/FMNR technical steward where compulsory (example: MXGP)) identified as "CLUTCH" on the drawing here above, positioned on the left side of the vehicle, between the handlebar and the footrest, shall disengage the clutch during the whole sound control procedure.

The SCO (and not others) shall open the throttle as fast as possible (instantly, within 0.3 s) until "full open throttle", in order to reach the maximum rpm value ("max. rpm").

For Motocross, Enduro/SuperEnduro/HardEnduro, Cross-country rallies/Bajas, Sand Races and Track Racing motorcycles with no FIM homologated silencers, the "max rpm" is the one defined by the ECU (for 4-stroke engines), or by a natural regulation (for 2-stroke engines).

When in doubt, it can be verified that such "max. rpm" value is higher than the rpm value at which the vehicle supplies its maximum power (kW) ("max. power rpm").

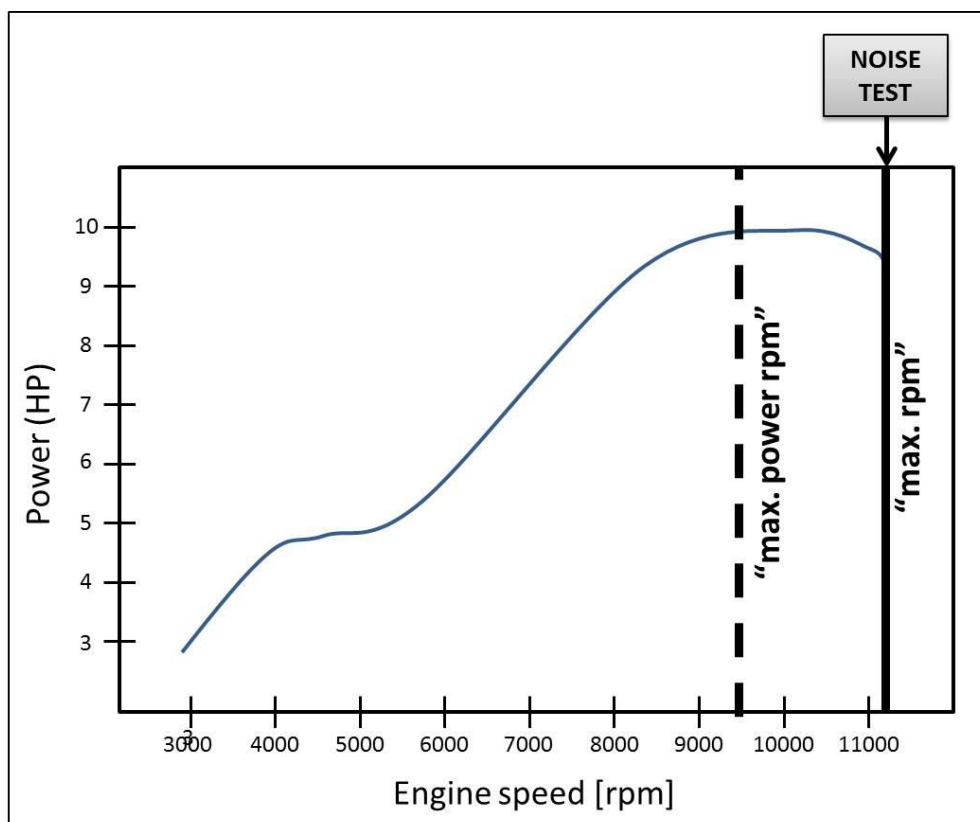

For Trial, the "max rpm" is established at 10000 (± 200) rpm and obtained thanks to a dedicated "sound test" mapping of the internal ECU or an external one, purpose-made and connected in occasion of the test.

For Track Racing with FIM homologated silencers, when sound tests are needed, the "max rpm" is established at 11000 (± 500) rpm.

The SCO then keeps the engine at the "max. rpm" value for at least 1 s (or until there is an audible sign of over-revving the engine), during which the measurement is taken.

To conclude the test, the SCO releases the throttle quickly.

The maximum noise value (dB/A) registered during the measurement interval is then read on the sound meter and recorded. This noise value shall not be rounded down to the nearest whole number.

The noise value is then compared with the sound limits (see **Art. E**).

The noise test can be "**PASSED**" or "**NOT PASSED**":

"PASSED": The sound test is considered "passed" if the recorded noise value is below or equal to the sound limits of **Art. E**. The silencer can then be marked by the SCO at the end of the test.

The silencer can be changed after verification under the conditions of Technical control.

The end opening of the silencer shall remain unmodified once it has been checked and marked.

"NOT PASSED": The sound test is considered "not passed" if the recorded noise value is above the sound limits of **Art. E**.

In this case, the vehicle (with the same silencer) can be presented again, but for two more tests maximum. If the third test result is negative, the rider can present a different or repaired silencer (in case the sound test was done before the race) will receive a penalty (in case the sound test was done during or after the race).

The sound meter is then reset by pushing on the side-line and armed by pushing on the side-line again.

Sound controls during the event or after the race:

- the motorcycle must be tested in the exact conditions at any time of the event when the FIM Technical Director requests the team/rider for a sound control.
- the motorcycle must be tested in the conditions it has finished the race and has rejoined the parc fermé.

Notes:

If the engine starts to misfire, close the throttle slightly and re-open the throttle.
If detonations appear, the measurement must be started again.

For vehicles without an engine rev. limiter, the throttle will have to be opened not more than 2 s or until there is an audible sign of over-revving the engine.

Even in case a vehicle has not exceeded the respective sound limit, if there is any doubt, the vehicle may be checked again.

If the vehicle is unable to reach the "max. power rpm" value, the vehicle shall be refused. Any attempt by a participant to prevent his engine from reaching the "max. power rpm" will be considered a breach of the rules.

In case the SCO doubts that the "max. power rpm" value (as declared by the manufacturers or previously obtained with the dyno test), he/she shall measure the engine speed with a tachometer connected to the spark.

The motorcycle must maintain at least the minimum RPM during the sound controls. Any motorcycle that is unable to reach and maintain the minimum RPM stated will be refused (applicable with the Race Patrol (/Lite) sound meter from EA LAB (or any other RPM readers)). In case of dispute, the decision of the FIM Technical Director will be final:

Minimum RPM thresholds		
Motocross, Supermoto & RallyGP		
50 cc 65 cc	2T	11500 rpm
65 cc to 85 cc		11500 rpm
100 cc to 125 cc		11000 rpm
175 cc to 300 cc		9000 rpm
85 cc to 150 cc	4T	13500 rpm
175 cc to 250 cc		13500 rpm
290 cc to 350 cc		12000 rpm
450 cc		10800 rpm
Sidencross		
	2T	8000 rpm
	4T	9000 rpm
Snowcross		
	2T	8000 rpm
	4T	TBC rpm
Quadcross		
up to 500 cc	2T	9000 rpm
up to 450 cc	4T	10400 rpm
451 - 500 cc	4T	9000 rpm

Enduro. Rally 2, Rally 3		
up to 125 cc	2T	11000 rpm
Over 125 cc		9000 rpm
up to 250 cc	4T	12000 rpm
250 - 350 cc		11000 rpm
350 - 450 cc		10000 rpm
Over 450 cc		9000 rpm
Quads		
TBC		TBC rpm
Trail		
Over 600 cc		TBC rpm
Flat Track		
250 - 500 cc	2T	9000 rpm
250 - 450 cc	4T	10800 rpm

Rain and wet conditions significantly alter the laws under which sound propagates. For the risk of misleading results and unrepeatable conditions, sound testing should not be performed when it is raining or conditions are wet. The decision of the Sound Control Officer and/or FIM technical Director to continue, suspend or stop the sound controls in rainy/wet conditions is final.

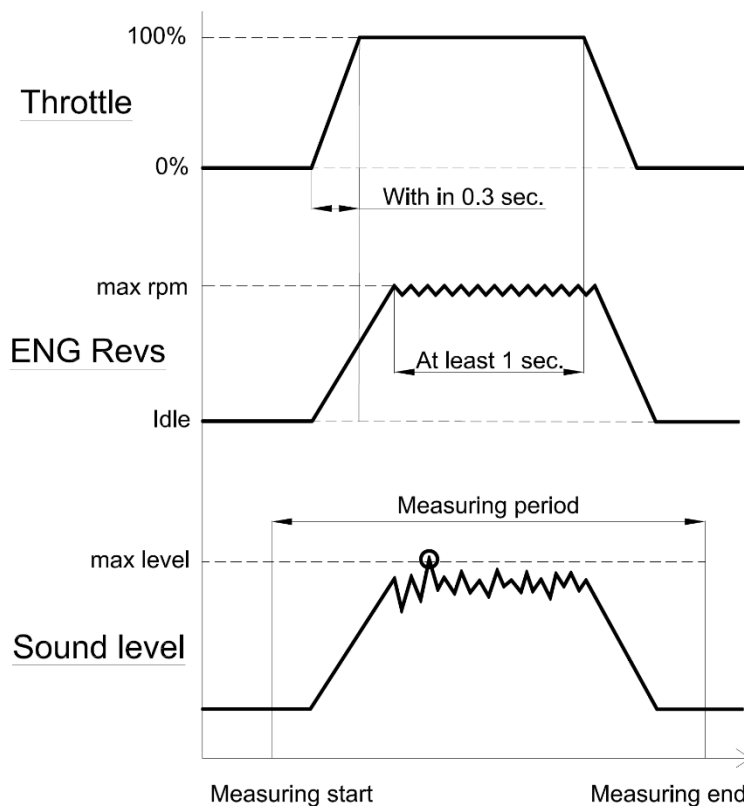

1. The Inspector shall open the throttle until full open throttle within 0.3 seconds.
2. And keep at the max rpm (at rpm limiter) at least 1 second. Then, release the throttle quickly.
3. The sound level is measured in the all period and the maximum level shall be recorded in any case. (automatically by the sound meter).

E. SOUND LIMITS

Below are listed the maximal sound limits by category and by type of engine.

- The values that have to be respected after the race take into account the degradation of the silencer (i.e. the limit is raised of 1 dB/A).
- The values already take into account the accuracy of the method.
- No deductions for ambient temperature, **wind**, pressure or altitude are allowed.
- The measured noise value shall not be rounded down to the nearest whole number.

1. TRIAL World Championships, Cups and Prizes

Type of engine	Maximum Sound limit in [dB/A]	
	Before the race	During or after the race
2-stroke	103.0	104.0
4-stroke	105.0	106.0

Table 1 : Sound limit for Trial

2. TRACK RACING World Championships, Cups and Prizes

Type of engine	Maximum Sound limit in [dB/A]	
	Before the race	During or after the race
All	115.0	116.0
2-stroke 4-stroke	(Target 113.0 + 2.0 for the precision of the method)	(Target 115.0 + 1.0 for the degradation of the silencer)
SGP4 4-stroke	111.0 (Target 109.0 + 2.0 for the precision of the method)	112.0 (Target 111.0 + 1.0 for the degradation of the silencer)

Table 2: Sound limit for Track Racing

3. FLAT TRACK World Championships, Cups and Prizes

Type of engine	Maximum Sound limit in [dB/A]	
	Before the race	During or after the race
All 2-stroke 4-stroke	114.0	115.0
As of 01/01/2026	111.0	112.0

Table 3 : Sound limit for Flat Track

4. ENDURO, SUPERENDURO, HARDENDURO World Championships, Cups and Prizes

Type of engine	Maximum Sound limit in [dB/A]	
	Before the race	During or after the race
All	111.0	112.0
2-stroke 4-stroke	(Target 109.0 + 2.0 for the precision of the method)	(Target 111.0 + 1.0 for the degradation of the silencer)

Table 4: Sound limit for Enduro, SuperEnduro, HardEnduro

5. SAND RACES World Championships, Cups and Prizes

Type of engine	Maximum Sound limit in [dB/A]	
	Before the race	During or after the race
All 2-stroke 4-stroke	111.0 113.0 (Target 111.0 + 2.0 for the precision of the method)	112.0 114.0 (Target 113.0 + 1.0 for the degradation of the silencer)
Quads: 2-stroke 4-stroke	111.0 113.0 (Target 111.0 + 2.0 for the precision of the method)	111.0 114.0 (Target 113.0 + 1.0 for the degradation of the silencer)

Table 5: Sound limit for Sand Races

As of 01/01/2027:

Discipline/Class	Maximum Sound limit in [dB/A]	
	Before the race	During or after the race
Quads: 2-stroke 4-stroke	111.0 (Target 109.0 + 2.0 for the precision of the method)	112.0 (Target 111.0 + 1.0 for the degradation of the silencer)

Table 6: Sound limit for Sand Races Quads as from 01/01/2027

6. CROSS-COUNTRY RALLIES & BAJAS World Championships and Cups

Type of engine	Maximum Sound limit in [dB/A]	
	Before the race	During or after the race
All 2-stroke 4-stroke	117.0 (Target 115.0 + 2.0 for the precision of the method)	118.0 (Target 117.0 + 1.0 for the degradation of the silencer)
As of TBA 2-stroke 4-stroke	TBA (Target 10X.0 + 2.0 for the precision of the method)	TBA (Target 10X.0 + 1.0 for the degradation of the silencer)

Table 7: Sound limit for Cross-Country Rallies & Bajas

7. MOTOCROSS World Championships, Cups and Prizes

Discipline/Class	Maximum Sound limit in [dB/A]	
	Before the race	During or after the race
MXGP, MX2, Women MX: 2-stroke 4-stroke	111.0 (Target 109.0 + 2.0 for the precision of the method)	112.0 (Target 111.0 + 1.0 for the degradation of the silencer)
Supercross (SX): 2-stroke 4-stroke	111.0 114.0 (Target 112.0 + 2.0 for the precision of the method)	112.0 115.0 (Target 114.0 + 1.0 for the degradation of the silencer)
Sidecar cross : 2-stroke 4-stroke	111.0 (Target 109.0 + 2.0 for the precision of the method)	112.0 (Target 111.0 + 1.0 for the degradation of the silencer)
Junior MX: 2-stroke (65/85) 2-stroke (125) 4-stroke	111.0 (Target 109.0 + 2.0 for the precision of the method)	112.0 (Target 111.0 + 1.0 for the degradation of the silencer)

Supermoto: 2-stroke 4-stroke	111.0 (Target 109.0 + 2.0 for the precision of the method)	112.0 (Target 111.0 + 1.0 for the degradation of the silencer)
Snowcross: 2-stroke 4-stroke	111.0 (Target 109.0 + 2.0 for the precision of the method)	112.0 (Target 111.0 + 1.0 for the degradation of the silencer)
Quadcross: 2-stroke 4-stroke	111.0 114.0 (Target 112.0 + 2.0 for the precision of the method)	112.0 115.0 (Target 114.0 + 1.0 for the degradation of the silencer)

Table 8: Sound limit for Motocross

As of 01/01/2027:

Discipline/Class	Maximum Sound limit in [dB/A]	
	Before the race	During or after the race
Quadcross: 2-stroke 4-stroke	111.0 (Target 109.0 + 2.0 for the precision of the method)	112.0 (Target 111.0 + 1.0 for the degradation of the silencer)

Table 9: Sound limit for Quadcross as from 01/01/2027

- The values that have to be respected after the race take into account the degradation of the silencer (i.e. the limit is raised of 1 dB/A).
- The values already take into account the accuracy of the method.
- No deductions for ambient temperature, **wind**, pressure or altitude are allowed.
- The measured noise value shall not be rounded down to the nearest whole number.



**FEDERATION INTERNATIONALE
DE MOTOCYCLISME**

FIM-MOTO.COM

ROUTE DE SUISSE 11 | 1295 MIES | SWITZERLAND

cti@fim.ch

6579006